

# Healthcare TV Mounts

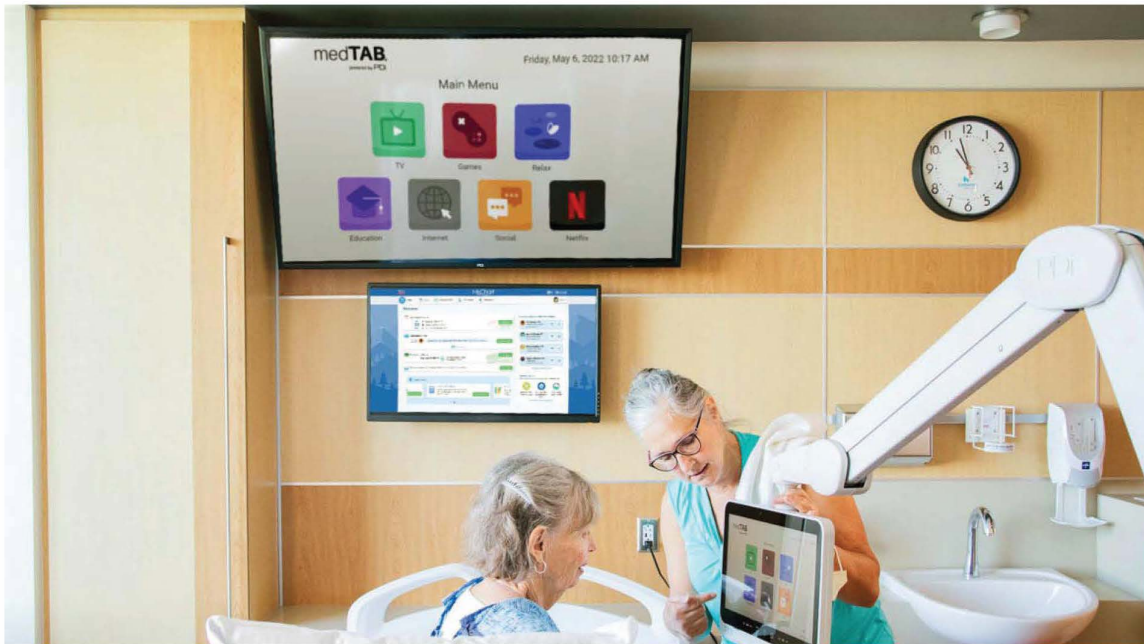

# TV Brackets & Mounting Solutions

For Patient Entertainment & Information Displays



PDi 55" Hospital TV and medTAB16 arm-mounted patient engagement system

From large-screen wall TV brackets, articulating mounts and displays, to personal arm-mounted systems and mobile TV carts, PDi has focused on complete healthcare solutions & services for patient entertainment and information since 1980.

With a variety of proven engineered products, designed and manufactured in the USA, having antimicrobial coatings, to meeting OSHPD seismic design requirements, (now referred to as HCAI) to design and supply of flat panel mounts and mobile carts, you can trust that PDi is dedicated to being your one-stop-shop for the right system that works in your unique healthcare spaces.

# Low Profile

## Flat Wall Mounts

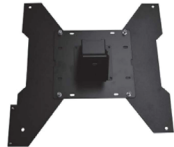
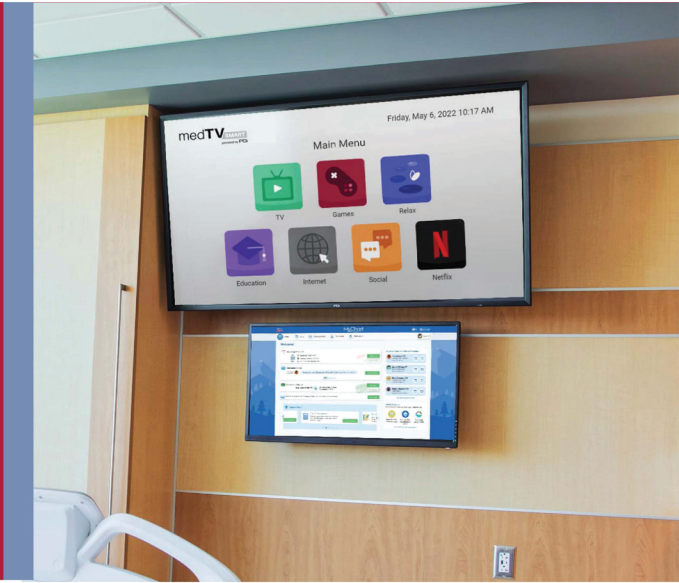

PD168-033	PD168-070	PD168-079	PD168-088
<p><b>Weight Capacity</b> 50 Lbs (22.7kg)</p>	<p><b>Weight Capacity</b> 50 Lbs (22.7kg)</p>	<p><b>Weight Capacity</b> 50 Lbs (22.7kg)</p>	<p><b>Weight Capacity</b> 50 Lbs (22.7kg)</p>
<p><b>Vesa Pattern</b> 200x200</p>	<p><b>Vesa Pattern</b> 400x400</p>	<p><b>Vesa Pattern</b> 100X100, 100x200</p>	<p><b>Vesa Pattern</b> 200 x300</p>
<p><b>Max Extension</b> 4.5 in. (11.4 cm)</p>	<p><b>Max Extension</b> 4.5 in. (11.4 cm)</p>	<p><b>Max Extension</b> 4.7 in. (12.0 cm)</p>	<p><b>Max Extension</b> 4.7 in. (12.0 cm)</p>
<p><b>Tilt</b> +5° to -30°</p>	<p><b>Tilt</b> +5° to -30°</p>	<p><b>Tilt</b> +5° to -30°</p>	<p><b>Tilt</b> +5° to -30°</p>
<p><b>Fits PDi A-Series Hospital TV</b> A43</p>	<p><b>Fits PDi A-Series Hospital TV</b> A55B</p>	<p><b>Fits PDi A-Series Hospital TV</b> A24, A32</p>	<p><b>Fits PDi A-Series Hospital TV</b> A65C</p>

**Need a Custom Mount?**  
**Call us Today!**  
 800.628.9870

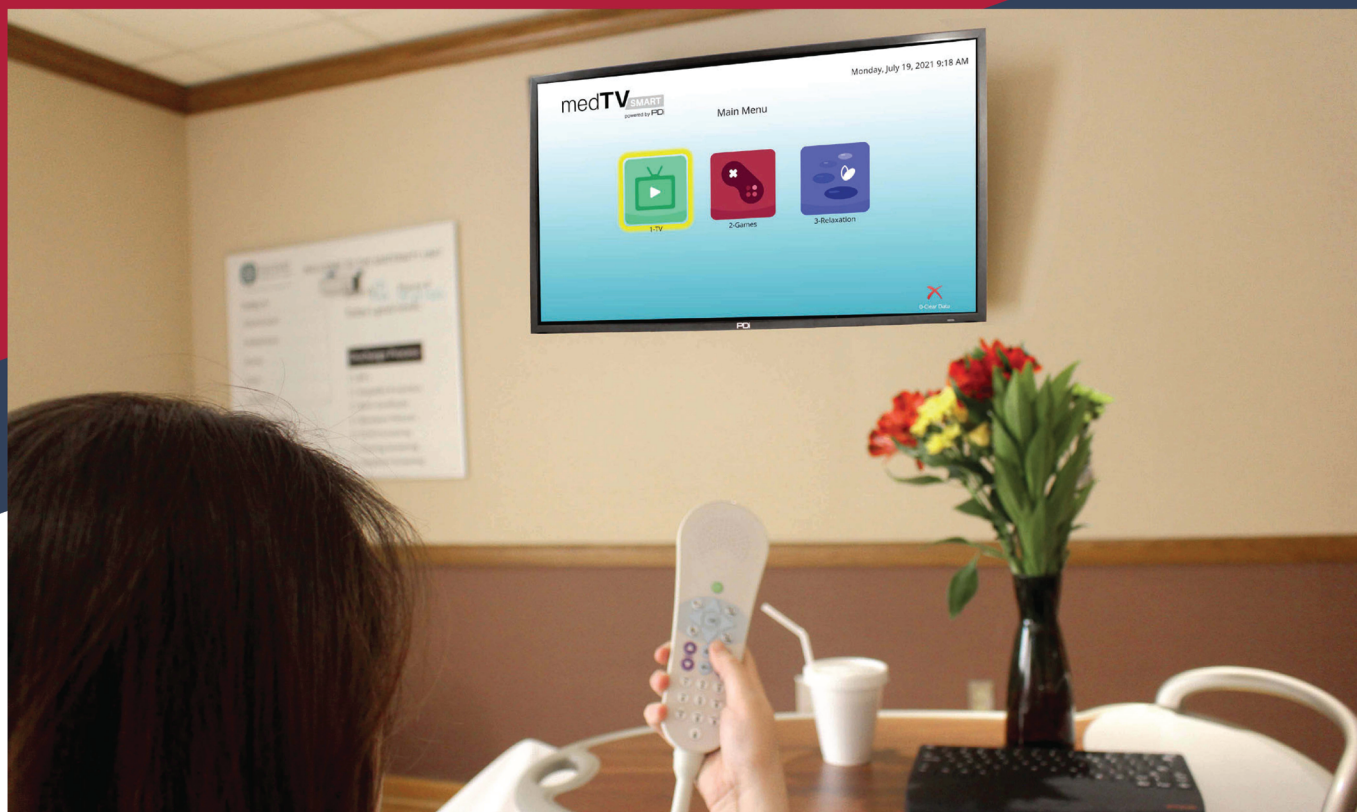

## Articulating Wall Mounts



Kit Includes  
PD181-700  
with Adapter  
Plate  
PD181-677



PD168-086	PD168-087	PD168-089	PD181-700	PD168-080	PD168-110
<p><b>Weight Capacity</b> 55 lbs (25 kg)</p>	<p><b>Weight Capacity</b> 55 lbs (25 kg)</p>	<p><b>Weight Capacity</b> 55 lbs (25 kg)</p>	<p><b>Weight Capacity</b> 30 lbs (13.6 kg)</p>	<p><b>Weight Capacity</b> 30 lbs (13.6kg)</p>	<p><b>Weight Capacity</b> 77 lbs (35.0 kg)</p>
<p><b>Vesa Pattern</b> 100x100; 100x200 200x200</p>	<p><b>Vesa Pattern</b> 400x400</p>	<p><b>Vesa Pattern</b> 200X300</p>	<p><b>Vesa Pattern</b> 75x75 100x100</p>	<p><b>Vesa Pattern</b> 100x200</p>	<p><b>Vesa Pattern</b> 100x200; 200x200; 200x300; 300x300 400x200; 400x400; 600x400</p>
<p><b>Max Extension</b> 10.5 in. (26.7 cm)</p>	<p><b>Max Extension</b> 10.5 in. (26.7 cm)</p>	<p><b>Max Extension</b> 10.5 in. (25 cm)</p>	<p><b>Max Extension</b> 12.6 in. (32.0 cm)</p>	<p><b>Max Extension</b> 12.6 in. (32.0 cm)</p>	<p><b>Max Extension</b> 20.5 (52.0 cm)</p>
<p><b>Tilt</b> +33° to -33°</p>	<p><b>Tilt</b> +33° to -33°</p>	<p><b>Tilt</b> +33° to -33°</p>	<p><b>Tilt</b> +12° to -12°</p>	<p><b>Tilt</b> +12° to -12°</p>	<p><b>Tilt</b> +10° to -20°</p>
<p><b>Fits PDi A-Series Hospital TV</b> A24; A32; A43</p>	<p><b>Fits PDi A-Series Hospital TV</b> A55B</p>	<p><b>Fits PDi A-Series Hospital TV</b> A65C</p>	<p><b>Fits PDi A-Series Hospital TV</b> A24</p>	<p><b>Fits PDi A-Series Hospital TV</b> A32</p>	<p><b>Fits PDi A-Series Hospital TV</b> A32, A43, A55, A65C</p>

# TV ENCLOSURES

For Ligature Resistance

Part Number: PD903-1006



## Enhance Patient Safety

PDi is proud to partner with TVArmor® (Jackson, NJ) for their patented TV Armor Enclosure. Designed to be mounted around a previously mounted TV, these enclosures prevent self-harm and provide peace of mind.

## Features

- Rounded Corners
- Anti-Ligature Sloped Top for Behavioral Health Applications
- Optical-grade Acrylic Front or Polycarbonate Front Panel, 200x stronger than Glass
- Black Anodized Aluminum Frame with Black Matte ABS Panels, matches TV or Monitor
- Two 5V Cooling Fans (Input 120V/15A and Output 5DC/1A), LED Fan Status Indicator, and Fused Fan Controller Standard
- Internal Mounting Feet
- Recessed Hardware
- No Keys Required

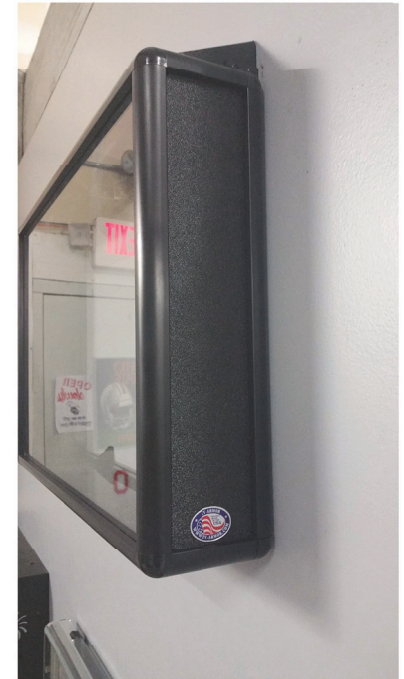

## Optional

- Lockable Access Door
- Pin-in-Torx Security Screws
- Media ports, USB, HDMI, 3.5mm Au

# Grid Ceiling Mounts

## Single or Dual Displays Mounts

Compatible with low profile wall mounts, see page 3

### PDI-LCD-GRID-MT PDI-DUAL-GRID-MT

<b>Weight Capacity</b>	65 lbs (29.5 kg)	65 lbs (29.5 kg)
<b>Vesa Pattern</b>	100x100;100x200 200x200;300x300 400x300;400x400	100x100;100x200 200x200;300x300 400x300;400x400
<b>Distance Beneath Ceiling Tile</b>	Min: 12 in (30.5 cm) Max: 30 in (76 cm) 2ft & 3ft kits available	Min: 12 in (30.5 cm) Max: 30 in (76 cm) 2ft & 3ft kits available
<b>Tilt</b>	33° to -33°	12° to -12°
<b>Fits PDI A-Series Hospital TV</b>	A24 A32 A43 A55B A65C	A24 A32 A43 A55B A65C



\*NOTE: When a Dual Grid Mount supports a 55" or 65" PDI TV, it can also only hold a 24" PDI TV.\*

### High Ceilings? No Problem

#### EXTENSION KITS

2ft PD168-082

3ft PD168-083

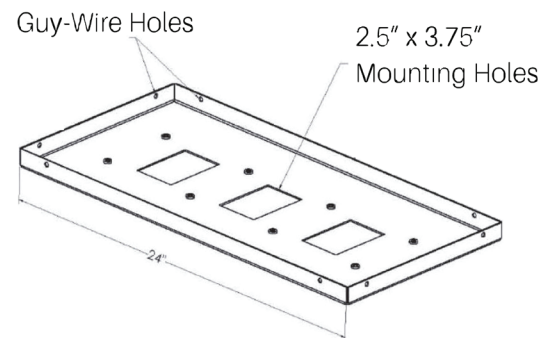

No one is more qualified to install PDI healthcare-grade entertainment solutions than the company that designs and builds them.

Call PDI ProServices Today  
800.628.9870

# Table TV Stands

### Part Number: PD168-108

- Adjustable bracket fits 200x200 up to 600x400mm VESA patterns
- Load Capacity 88lbs. (40kg)
- Solid tempered-glass base
- Unit Weight 15.95lbs. (7.28kg)
- Fits A-Series displays:  
A43, A55B, A65C



Universal Mount TV Table Stand

### Part Number: PD168-084

- Compatible with VESA patterns 75x75 to 600x400
- Load Capacity 110lbs. (49.9kg)
- Unit weight 5.9lbs (2.6kg)
- Fits TV displays up to 70"
- Black matte finish
- Fits A-Series displays: 24", 32", 43", 55", 65"



Table TV Stand



# **PDI EXPERTS UNDERSTAND THE IMPORTANCE OF THE PATIENT EXPERIENCE.**

We plan, build, customize, and install  
TV solutions for healthcare.

# Arm TV Mounts

Provide the ultimate comfort for patients



Since 1980, PDi has designed and built complete, arm-mounted TV solutions to fit a wide range of healthcare settings. There isn't much we haven't solved for already! As an American manufacturer, we build safety, infection control, and quality into everything we make.

Don't see what you need? Utilize PDi's FREE consultation and experienced staff in your next project to ensure the right TV and mount system for your unique patient space.

## Check out the popular ways to better reach patients with PDi.

**IN-PATIENT HOSPITAL SPACE**  
Headwall Mount



**\*DIALYSIS OR INFUSION CLINIC SPACES**  
Standard Wall Mount



New Construction

Renovation Backer Plate

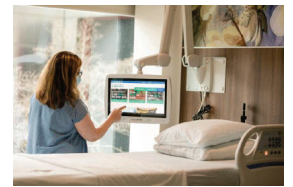

**RENOVATIONS OR LOW CEILING SPACES**  
Horizontal Arm Mount



**DIALYSIS OR INFUSION CLINIC SPACES**  
Cabinet Table Top Mount

**\*EXAM ROOM WITH CONCRETE FLOORS 48"**  
Floor Mount



**SUSPENDED CEILING OR GLASS WALL SPACES**  
Ceiling Mount

**LIMITED MOBILITY PATIENTS**  
Hi-Tilt Mount



**SOLID SURFACE COUNTERTOPS**  
Right Angle Mount

**HIGH CEILING SPACES**  
Super Reach Arm Mount

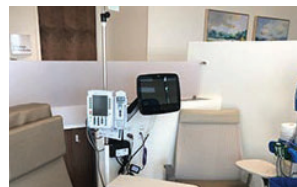

**HALF-HEIGHT WALL CLINIC SPACES**  
SpaceSaver REACH17



\*OSHPD Approved Designs is now known as the Department of Health Care Access and Information

**Better solutions are within reach®**



Ask about Guaranteed Installation Services



# Hospital TV Carts and Telehealth Solutions

Find the right solutions for an ever-changing healthcare system



## Smart Inpatient TV Solutions

A flexible solution to deliver entertainment to patients and visitors.

Connect patients with loved ones and physicians through video calls

Motivate patient interaction and improve the patient experience for any comfortable viewing angle.

## Let's Work Together

800-628-9870

### Mobile Entertainment to Engage Patients and Visitors

Great for small infusion, dialysis or exam room spaces or temporary hospital spaces.



# We Deliver the Patient Experience You Envision

Start to finish, PDi and the ProServices team ensures your needs are met. PDi sets the standard of excellence in customer service and support. Call us today for a FREE consultation!

Call: 800-628-9870 Email: [salesinbox@pdiam.com](mailto:salesinbox@pdiam.com)

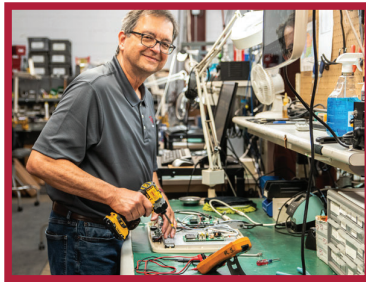

## Proven Experience You Can Trust

For over 40 years, PDi has been the only American manufacturer of complete patient TV solutions to fit the demanding and evolving needs of healthcare environments.

